

IMPORTANT INSTRUCTIONS



Smart Heating Solutions

PX-ECO 2-Stage Electronic Heater
With Remote Control and Remote Sensor



⚠ DANGER ⚠

ELECTRIC SHOCK OR FIRE HAZARD

Read all wire sizing, voltage requirements and safety data to avoid property damage and personal injury.



Remote



Remote Sensor



Figure 1

Covers all PX-ECO models

⚠ WARNING ⚠

Read Carefully - These instructions are written in an effort to prevent potential difficulties that might arise during installation. Studying the instructions first may save you considerable time and money later. Observing the following procedures will keep installation time to a minimum. **Save these instructions for future use.**

IMPORTANT INSTRUCTIONS

When using electrical heating appliances, basic precautions should always be followed to reduce the risk of fire, electric shock and injury to persons, including the following:

1. **Read all instructions before wiring or using this heater.**
2. **WARNING:** This heater is hot when in use. To avoid burns, do not let bare skin touch hot surfaces. Keep combustible materials, such as furniture, pillows, bedding, papers, clothes, boxes, etc., and curtains at least 3ft (.9 m) from the front of the heater and keep them away from the sides and rear.
3. **CAUTION:** Extreme caution is necessary when any heater is used by or near children or invalids and whenever the heater is left operating and unattended.
4. Do not operate any heater after it malfunctions. Disconnect power at service panel and have heater inspected by qualified electrician for repair before reusing.
5. Do not use outdoors.
6. **WARNING:** To disconnect heater, turn controls to OFF, and turn OFF power to heater circuit at main disconnect panel.
7. **WARNING:** Do not insert or allow foreign objects to enter any ventilation or exhaust opening as this may cause an electric shock, fire, or damage to the heater.
8. To prevent a possible of fire, do not block air intakes or exhaust in any manner.
9. A heater may have hot and arching or sparking parts inside. Do not use it in areas where gasoline, paint, or flammable vapors or liquids are used or stored.
10. **WARNING:** Use this heater only as described in this manual. Any other use is not recommended by the manufacturer and may cause fire, electric shock, explosion or injury to people and or property.
11. All electrical work and materials must comply with the National Electric Code (NEC), the Occupational Safety and Health Act (OSHA), and all state and local codes.
12. Use copper conductors only.
13. Verify that the electrical supply wires are the same voltage as the heater.
14. Heater must be installed in a wall can.
15. Use orient ring to properly align wall can and make sure it is flush with sheetrock.
16. **DO NOT** select a location where it is likely to be blocked by furniture, curtains, etc.
17. Be sure the location selected allows sufficient space for the heater as shown by Table 1.
18. Connect grounding lead to grounding screw provided. Keep all foreign objects out of heater.
19. **DANGER.** High temperatures may be generated under certain abnormal conditions. Do not partially or fully cover or obstruct the front of this heater.



PX INSTALLATION INSTRUCTIONS

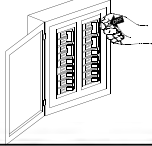

CAUTION!
Turn OFF all electrical power to install heater

What's The Right Heat Output For My Room?

To get the most energy efficient heat output for your room, determine the square footage of the room to be heated and multiply by 10 to get the wattage required.

Example

Room Size (10 ft. x 15 ft.) = 150 sq. ft.
150 sq. ft. x 10 watts/sq. ft. = 1500 watts
Solution: Select 1500 Watt setting during installation.

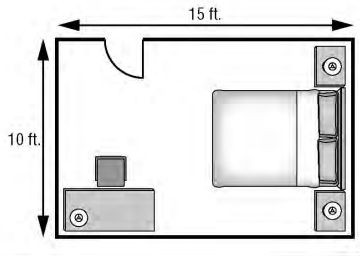

Heater Placement

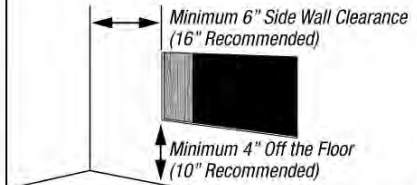

Selecting A Location For Your Heater:

DO NOT install less than 6" (15cm) from vertical side walls or open edge of door. This heater must have an unrestricted air-flow. DO NOT select a location where it is likely to be blocked by furniture, curtains, etc. Be sure the location selected allows sufficient space for the heater as shown by Table 1. DO NOT locate this heater in an area where combustible vapors, gases liquids, or excessive lint, dust or moisture is present.

Minimum Clearances for heater: Table 1

Front	TOP	BOTTOM	SIDES
36 in	12 in	4 in	6 in
0.9 m	30.5 cm	10.2 cm	15.2 cm

* Rated for zero clearance to insulation.

Wire and Breaker Sizing:

The wire and breaker sizing chart will give a general rule of installation size. Consult an electrician if you are not knowledgeable about wiring codes.

Table 2:

Total Amps	Minimum AWG. Wire Size (Copper)	Circuit Breaker or Fuse Size
0 thru 12	#14	15 amp
12.1 thru 16	#12	20 amp
16.1 thru 24	#10	30 amp

INSTALLATION INSTRUCTIONS

STEP 1 Route Supply Wires

Route supply wire from the circuit breaker to the stud cavity where the heater/wall can will be located.

STEP 2 (NEW CONSTRUCTION ONLY)

Mount Orientation Mounting Plate

For new construction use orientation ring as a guide for cutting the sheetrock. Position orientation mounting plate horizontally on studs, with label facing you, and attach to both studs with two wood screws (not included) on each side (See Figure 1). Use a level to ensure proper alignment. The 90 degree lip on the inside of the orient ring cutout should butt up to a wall stud on the left side. Proceed with drywall installation.

Figure 1

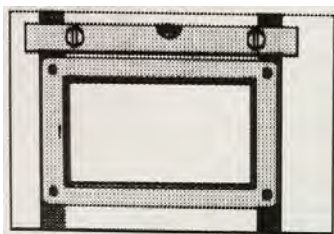

STEP 3 Cut Sheetrock and Mount The Wall Can

Cut out a hole in the sheetrock using a sheetrock saw (not included). For new construction with orientation ring installed, use orientation ring as a guide. For remodel installations (without orientation ring installed behind the sheetrock), the wall can will fit between 2 studs which should be installed 16" on center per building code. Cut a hole in sheetrock approximately 14-1/2 inches wide by 8.5 inches tall. Secure supply wires to wall can prior to mounting wall can in wall.

Remove a knockout from the wall can and attach the supply wire with a strain relief connector (not included) leaving a minimum of 6 inches wire lead. Connect supply ground wire to grounding screw in wall can with a wire connector (not included).

Mount the wall can securely to wall studs with 4 screws (not included) through holes provided in the wall can.

STEP 4 Install Heater Assembly

Orient heater assembly in wall can. Connect the supply wires to the heater with insulated wire connectors (not included). Secure with 3 screws provided into mounting tabs.

STEP 5 Install Grill

Install grill securely with 2 provided screws. Do not over tighten.

208V / 240V MODELS WIRING DIAGRAM

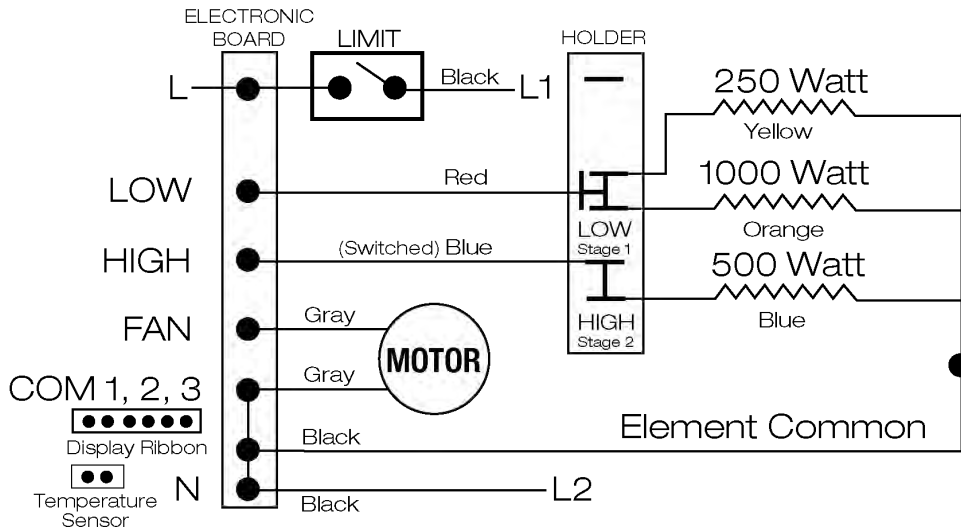

208V / 240V MODELS WATTAGE SELECTION

208V or 240V: 1750W TOTAL : 1000W + 500W + 250W

The heater is factory wired to 1750 Total Watts at 208/240 Volts (1750 Watts Stage 1 - HIGH Heat / 1250 Watts Stage 2 - ECO (Low Heat)). To change wattages, unplug quick connects from the terminal board and reposition onto the HIGH/LOW terminals per the chart below. Plug any unused wattage quick connects onto the HOLDER location on the terminal board.

Orange Wire	1000 Watt Element
Blue Wire	500 Watt Element
Yellow Wire	250 Watt Element
Black Wire	DO NOT DISCONNECT (Common)

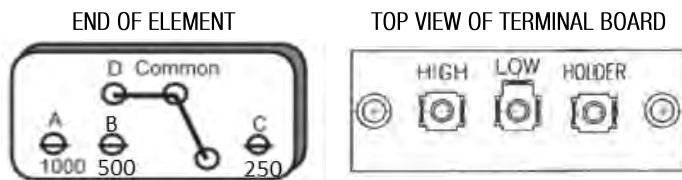

Room Size	Pic-A-Watt Selection*	HEATING STAGES		Energy Saved	TERMINAL BOARD TERMINATIONS		
		STAGE 1 HIGH HEAT	STAGE 2 ECO (LOW HEAT)		HIGH (Switched)	LOW (Always ON)	HOLDER
175 SqFt	1750 Watts	1750 Watts	1250 Watts	500 Watts	BLUE	ORANGE + YELLOW	N/A
150 SqFt	1500 Watts	1500 Watts	1000 Watts	500 Watts	BLUE	ORANGE	YELLOW
125 SqFt	1250 Watts	1250 Watts	1000 Watts	250 Watts	YELLOW	ORANGE	BLUE
75 SqFt	750 Watts	750 Watts	500 Watts	250 Watts	YELLOW	BLUE	ORANGE

* Maximum wattage can be selected at time of installation, tailoring the heater to a room's specific heating requirements.

** 240V rated heaters will draw 13% less amps and 25% less wattage when operated at 208V

*** Model PX2017-ECO: 208V specific model available with wattage options of 1750W · 1500W · 1250W · 750W

120V MODEL WIRING DIAGRAM

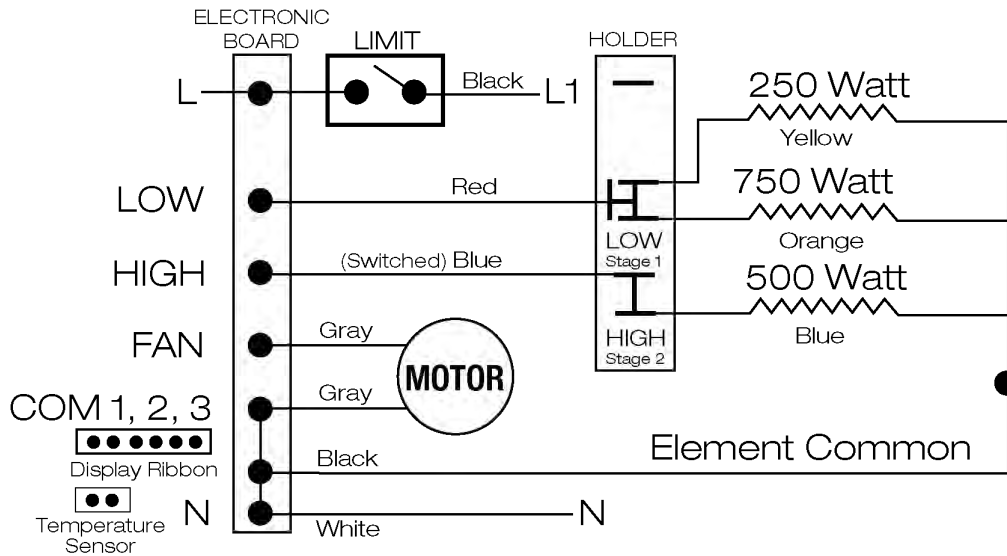

120V MODEL WATTAGE SELECTION

120V: 1500W TOTAL : 750W + 500W + 250W

The heater is factory wired to 1500 Total Watts at 120 Volts (1500 Watts Stage 1 - HIGH Heat / 1000 Watts Stage 2 - ECO (LOW Heat)). To change wattages, unplug quick connects from the terminal board and reposition onto the HIGH/LOW terminals per the chart below. Plug any unused wattage quick connects onto the HOLDER location on the terminal board.

Orange Wire	750Watt Element
Blue Wire	500 Watt Element
Yellow Wire	250 Watt Element
Black Wire	DO NOT DISCONNECT (Common)

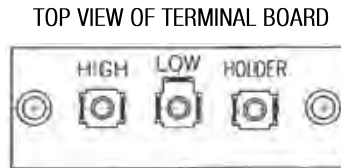
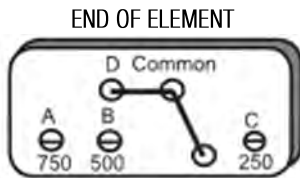

Room Size	Pic-A-Watt Selection*	HEATING STAGES		Energy Saved	TERMINAL BOARD TERMINATIONS		
		STAGE 1 HIGH HEAT	STAGE 2 ECO (LOW HEAT)		HIGH (Switched)	LOW (Always ON)	HOLDER
150 SqFt	1500 Watts	1500 Watts	1000 Watts	500 Watts	BLUE	ORANGE + YELLOW	N/A
125 SqFt	1250 Watts	1250 Watts	750Watts	500 Watts	BLUE	ORANGE	YELLOW
100 SqFt	1000 Watts	1000 Watts	750 Watts	250 Watts	YELLOW	ORANGE	BLUE
75 SqFt	750 Watts	750 Watts	500 Watts	250 Watts	YELLOW	BLUE	ORANGE

* Maximum wattage can be selected at time of installation, tailoring the heater to a room's specific heating requirements.

SETUP OF REMOTE TEMPERATURE SENSOR

A wireless temperature sensor is provided to monitor the ambient temperature from any remote location. It needs to be paired with the heater and will transmit real-time temperature to the heater for highly accurate room temperature control.

Sensor Placement

Important: Avoid areas that can have temperature extremes, making the sensor think the room is cooler or warmer than it actually is. Don't install the sensor near doors that could let in drafts, or on exterior walls or near windows in direct sunlight.

ECO2S REMOTE SENSOR:

IMPORTANT: The remote sensor must be paired to the heater prior to use. If display shows "L5" the sensor has not been paired successfully. Repeat Pairing Process

Technical Specifications:

Protocol: Wireless 2.4G
 Transmit Distance: 98'
 Working Voltage: DC 3V (battery);
 Detecting Temperature: 0° to 99°F

Product Overview

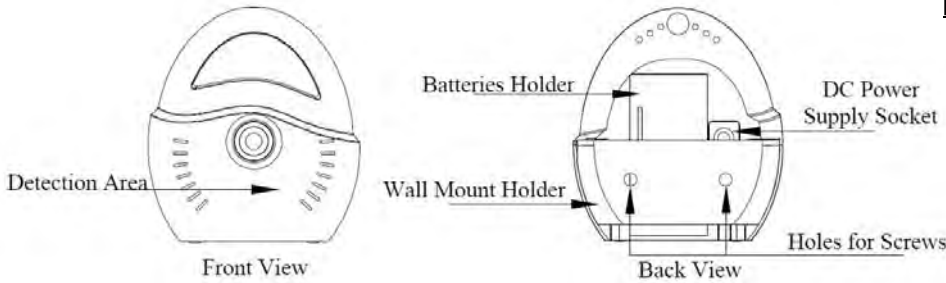

PX-ECO

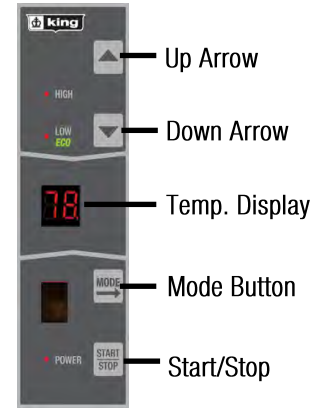

Pairing and Installation Guide

Since it is possible that more than one heater/sensor would be used in a home, you must first pair the remote sensor to a specific heater. Each remote sensor has a unique ID number, which will be used in the pairing process. When installing the remote sensor first time, users need to pair the remote sensor with PX heater, so the heater can learn and save the remote sensor's ID.

Step 1: First, power off the remote sensor (remove the battery or unplug the adapter).

Step 2: On the Heater's Display Press **START STOP** and button at the same time for 5 seconds. The LED display will flash "id".

Step 3: Release buttons, put the remote sensor within 3 feet of the heater and power on the remote sensor again. The green LED light in the remote sensor will flash, and PX the controller display indicator lights will illuminate (LED tubes show 88) for 1 second and then turn off. This means the remote sensor and the controller have paired with each other successfully.

NOTE: If the PX display flashes "id" for 20 seconds and then turns off, it means that the heater failed to pair with the remote sensor and has exited the Pair mode. Repeat the above steps to pair the remote sensor.

Step 4: After pairing the remote sensor successfully, put the sensor in the room where you want to detect temperature. The PX heater display will now display the temperature from the remote sensor.

Installing Batteries

Open the battery cover and insert 2pcs AAA batteries, reinstall the battery cover.

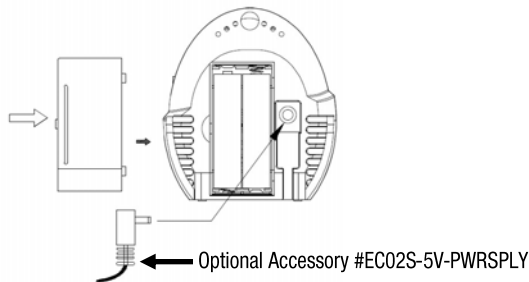

Mounting The Remote Sensor

Sensor can be placed on any flat surface or can be fixed to the wall with the mounting bracket. **Mounting Bracket Install:** Select location for the sensor on the wall. Secure the bracket to with 2 appropriate anchors and screws. Insert remote sensor into bracket.

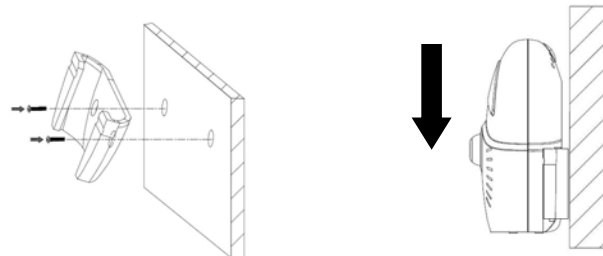

Low Battery Indicator

When batteries are low, "BA" will flash on the PX heater display to indicate batteries should be replaced. **Note:** If batteries fail, the PX is designed to revert back to the onboard temperature sensor for temperature control until the batteries are replaced in the remote sensor.

Low Signal Indicator

When the sensor is not paired with the heater or if the signal is being blocked, the display flashes "LS". After 10 minutes, the controller will automatically switch to work with the on-board temperature sensor, but the display will continue to flash "LS" until the signal restored.

1. Following Pairing process above to successfully pair the sensor.
2. Move Sensor closer to the heater or away from metal objects that might block the signal.

ECO2S CONTROL FEATURES



Electronic Controller Features:



- 2-Stage Heating that automatically uses the lowest wattage needed to heat the room
- Remote Temperature Sensor For Accuracy
- Remote Control and Wall Bracket Included
- Thermostat timer mode (1-9 Hours)
- Energy-saving automatic 2-stage heating
- Fan only mode
- Large LED display
- Built-In fan delay
- Display Lock Feature
- Bedroom or Standard “Environment” Models

OPERATING INSTRUCTIONS

Operation



1. Push the  button, the heater will come on and heat to the default setting of 72°F.
2. Once the room temperature reaches the set point, the heat elements will turn off followed by a 3 minute fan delay period to exhaust excess heat from the case. Afterwards the unit will turn off.
3. In normal operation the display will show the current room temperature.

Automatic 2-stage HIGH/LOW operation

Eco2S controller offers energy efficient 2-stage heating, automatically using the lowest wattage required to heat the room.

- During operation, when the set temperature is within 3 degrees of the room temperature the heater automatically switches to ECO mode, operating at LOW wattage.



Room Temperature Selection

- During operation, push  or  arrow buttons to set the temperature from 40°F-95°F, Hold down the UP or DOWN arrow to speed up the selection process. The LCD will go back to display room temperature after 5 seconds.

Timer Mode Selection

- During operation, press the  button 1 time, the display window will show the timer mode setup. Push  or  to set Timer from 1 hour—9 hours.

Fan Only Mode Selection

- During operation, press the  button 2 times, the display window will show [H] (Heat Mode) or [F] (Fan Only Mode).
Push  or  to switch between Fan Only and Heat modes.

Heater Display Control Panel

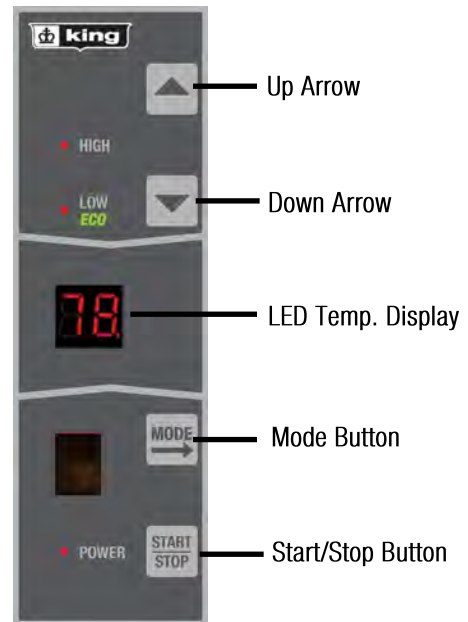

OPERATING INSTRUCTIONS CONTINUED





Display Lock Feature

Display Lock is designed for high traffic areas and deactivates the heater display buttons to prevent unwanted temperature adjustments. However settings can still be adjusted through the remote control.

- During operation, press the  button and HOLD for 5 seconds to set the display lock. [L] will appear on the display temporarily if a user attempts to make a temperature adjustment.
- While in Display Lock, heater can be adjusted using remote control.

Setting "Environment" Mode

Two Environment Options: Standard [SF] and Bedroom [BE]. Bedroom Mode turns off the display after 30 seconds for people using this heater in a bedroom environment. Once any button is pressed the display turns back on.

- During operation, press the and HOLD the  and  buttons for 3 seconds. Then press  or  to select "Bedroom Mode" [BE] or "Standard Mode" [SF]

Factory Reset





- During operation, press the and HOLD the  button for 5 seconds to reset to the factory settings. [FA] will flash on the display once done.

Sensor Error Code

- During operation, if the display shows [E1] that indicates an issue with the sensor and the sensor needs to be replaced. Contact customer support for assistance.

Setting Differential Value

The differential or gap affects how often the heater cycles. The lower the differential setting, the more the heater will cycle. If heater cycles too often, raise the differential setting to a higher degree.

- Press the and HOLD the  and  buttons for 5 seconds. The display will show the previously set differential. Press  or  to adjust the differential value between -0 to -5.

Heater Display Control Panel

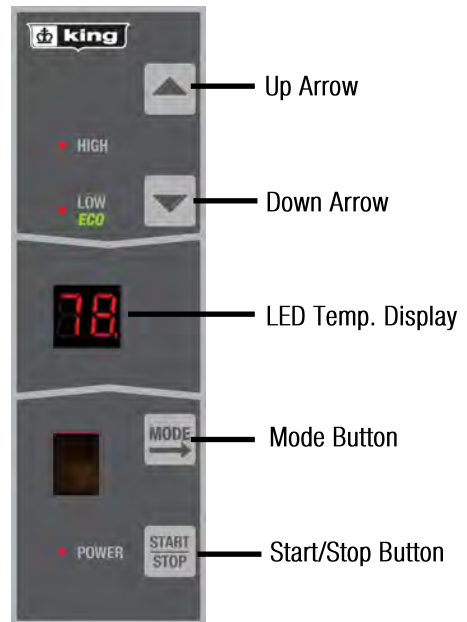

SMART LIMIT PROTECTION



This heater is equipped with a thermal overload Smart Limit Protection which disconnects elements and motor in the event normal operating temperatures are exceeded. If thermal overload trips due to abnormal operating temperatures, thermal overload shall remain open until manually reset by turning the heater OFF for fifteen minutes. Inspect for any objects on or adjacent to the heater that may cause high temperatures. After inspecting the heater, keep the power to the heater off for 10 minutes to reset the SLP thermal protector. If the SLP thermal protector shuts the heater off again, immediately turn the heater OFF at the circuit breaker and inspect the heater for possible fan motor failure or dirt and lint on the heating element. Repeat the starting procedure. **DO NOT TAMPER OR REMOVE THIS DEVICE.**

TROUBLESHOOTING & MAINTENANCE

SYMPTOM	PROBLEM	SOLUTION
Breaker Trips	<ol style="list-style-type: none"> Short Circuit Overloaded Circuit Improper Voltage 	<ol style="list-style-type: none"> Find source of short. Trace heater circuit and verify the heater is wire properly. Reduce wattage in circuit. Refer to circuit sizing table for maximum wattage. Verify the heater voltage matches the supply voltage.
Heater not working	<ol style="list-style-type: none"> No Power Loose Connections Defective Limit 	<ol style="list-style-type: none"> Turn Breaker & Thermostat ON, check that breaker is properly on panel bus-bar. A 2-Pole breaker must be connected to both bus-bars (A&B phase) to produce 240V power. Tighten wire connections. By-pass the limit to test. If heater works, replace the limit.
Heater Smokes	<ol style="list-style-type: none"> Oil on Element Needs Cleaning 	<ol style="list-style-type: none"> It is normal for the element to burn off some light finishing oil used in the manufacturing process when first energized. Open windows and allow room to vent until it stops, usually within a few minutes. Remove any dust or dirt accumulations.

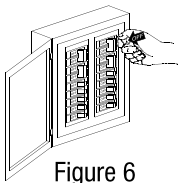

Figure 6

Maintenance & Cleaning: Basic maintenance is listed below and should be performed annually. When necessary, any required servicing should be performed by qualified service personnel. Your heater will give you years of service and comfort with only minimum care. To assure efficient operation follow the simple instructions below.

WARNING: Turn the electrical power OFF at the electrical panel board (circuit breaker or fuse box) and lock or tag this panel board door to prevent someone from turning on power while you are working on this heater. Failure to do so could result in serious electrical shock, burns, or possible death.

- Before removing grill, turn the electrical power OFF and elements to cool. Circuit breakers are often not marked correctly and turning the wrong breaker off could mean electricity is flowing to the heater, even if the heater does not appear to be working. If you are uncomfortable working with electrical appliances, unable to follow these guidelines, or do not have the necessary equipment, consult a qualified electrician. Once you verify the power is off completely and element is cool, proceed to the next step.
- Remove screws and take off grill. Wash grille with hot soapy water and dry immediately
- Using a hair dryer or vacuum on blow cycle, blow debris back through the element. Do not touch element. Vacuum or use a soft brush and remove loose debris without touching the elements. The fan motor does not require lubrication.
- Re-attach grill and secure with screws.
- Turn thermostat to desired setting.
- Turn power back ON at the electrical panel board.

WARNING: All other servicing should be performed by authorized service personnel.

DO NOT RETURN PRODUCT
 Are you experiencing difficulties?
We're Here to Help!
 Call Us Toll Free at:
1-800-603-5464
(Select Option 2 from the Menu)
 7:00 am -3:30 pm PST Mon-Fri
 Or email us at tech@king-electric.com
Please have the following information available:
 ✓ Supply Voltage ✓ Heater Model Number
 ✓ Remote or Inbuilt Thermostat? ✓ Date of Installation